

MOH 55 PRO USER MANUAL

ACCESSORY/STRUCTURE

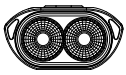

MOH 55 Pro

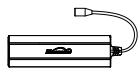

Battery pack(MJ-6118)

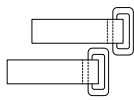

Magic strap



Wire clip



Headlamp Mount Assembly

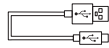

USB-C



Nylon strap



Helmet mount

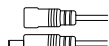

Extension cord

FEATURES

- Two high power XHP50.2 LEDs; 90 degrees flexible head angle adjustment.

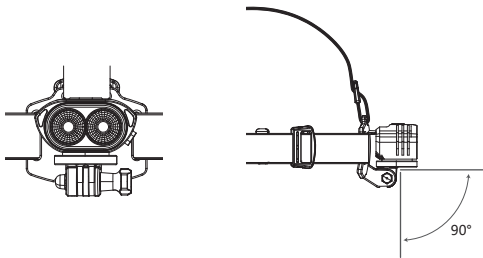

- Strap with reflective function.



- High capacity 7.2V 10Ah 21700 battery pack (MJ-6118).
- The battery pack can support fast charging and discharging and is able to work as an independent power bank. (MJ-6118 using USB-Ccharging & Discharging port, battery packs can be charged with MAGICSHINE dedicated chargers).
- IPX6 waterproof rate.

HOW TO ASSEMBLE

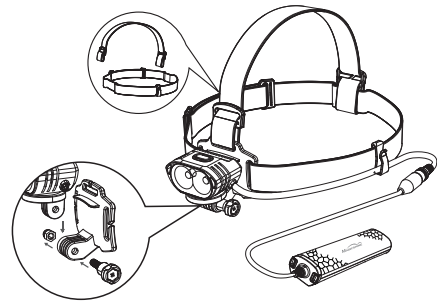

BUTTON FUNCTION

- Long press the power button 0.5s to turn ON/OFF.

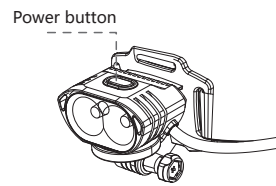

- Modes switch: with the light on, in constant mode, double click to switch into flash mode, single press back to constant mode.

- In constant mode, single press to change levels.

POWER INDICATOR



GREEN
100%-75%



FLASH GREEN
74%-50%



RED
49%-25%



FLASH RED
24%-1%

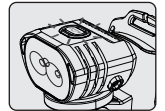

HOW TO RECHARGE(MJ-6118)

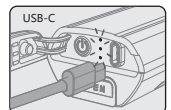
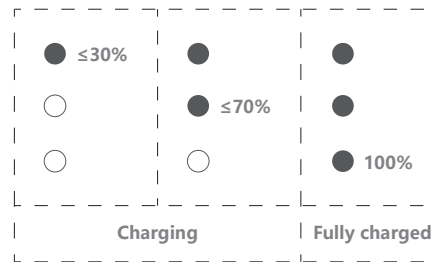



Standard charging time
Approx. 9.Shrs (5V 2A)

MODE OPERATION

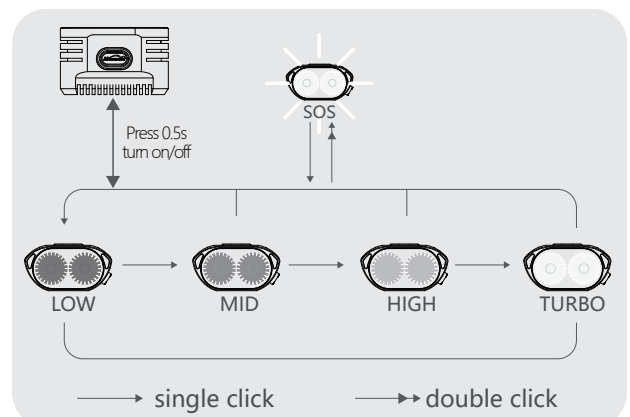
Mode memory: the light remains in the output setting it is switched OFF in.



LUMENS/RUN TIME(MJ-6118)

MODE	BRIGHTNESS	LOW	MID	HIGH	TURBO	SOS
	 LUMENS	100	600	1500	4000	/
	 h:min	89:00	20:30	06:30	02:25	/

WARNING



Do Not Look Directly Into Light Beam Or Shine Into Eyes Of Another.

EN WARRANTY

The Magicshine lighting system is warranted for 24 months from the date of purchase.

If you register the lighting system on the Magicshine website you will receive a bonus 6 month warranty.

Battery packs and AC adapters have a 6 month warranty, however, there is no bonus warranty available.

The warranty is limited to defects in material and workmanship on the lighting system itself, the battery pack and the AC adapter.

The warranty is only valid if the affected parts have not been tampered with and there is no intentional damage. Please keep your proof of purchase in a safe place. Proof of purchase must be presented in the event of any claim. Please contact the specialist retailer from whom you purchased the device for complaint or warranty claim.

Alternatively, you can send your complaint or claim directly to Magicshine at

Tel: (+86) 755-295 536 69

Fax: (+86)755-275 897 77

E-mail: support@magicshine.com (order from Magicshine.com online store)

service@magicshine.com (order from other sales channels)

In the event of a justified warranty claim and delivery of a replacement device, you will only be entitled to a model available when replacing.

The manufacturer retains the right to make technical modifications.

ANSI FL 1 STANDARD

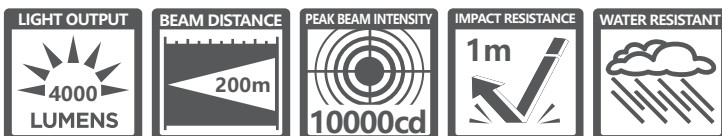

1. LED: CREE XHP 50.2 x 2

2. Size: 54.6x34x28.5 mm

3. Weight: 152g (battery not included)

